

Konsernet

A.S. FISKEVEGN

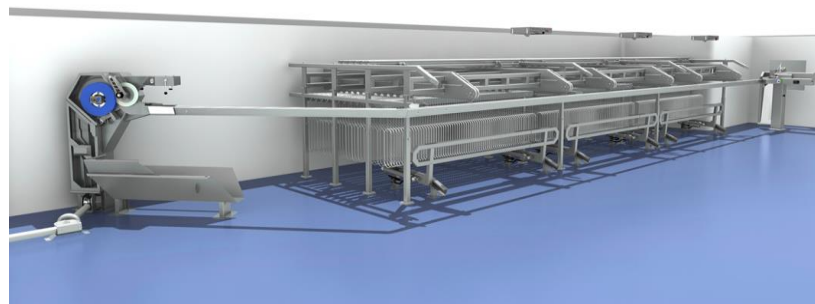

Flatraket Industribygg AS

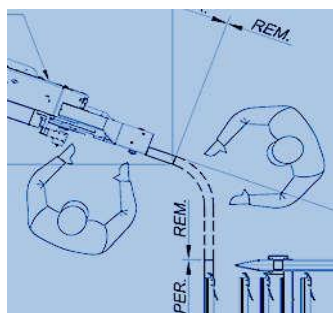

Storvika AS

Ålesund

MAGISTR-FISKEVEGN GROUP.MFG

LATVIJA · NORVÈGIJA

Kvernevik Gruppa

Kvalitet og utvikling i fokus

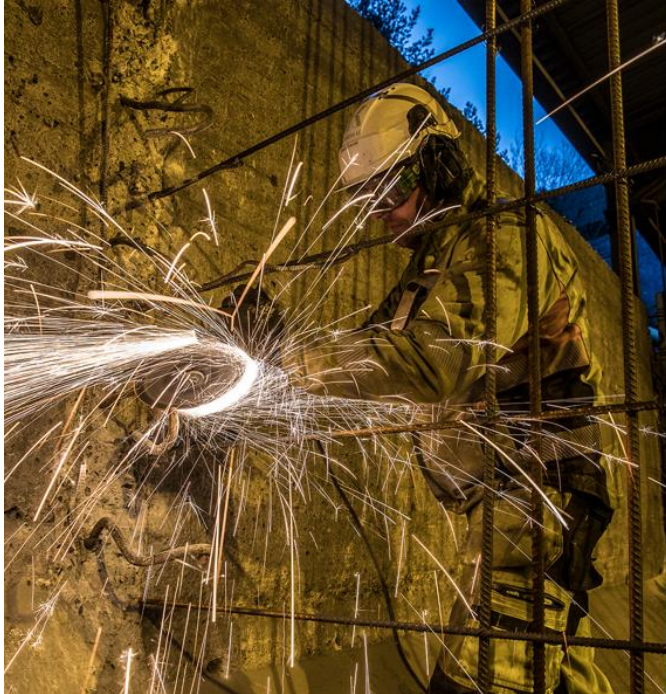

Flatraket Maritime Base

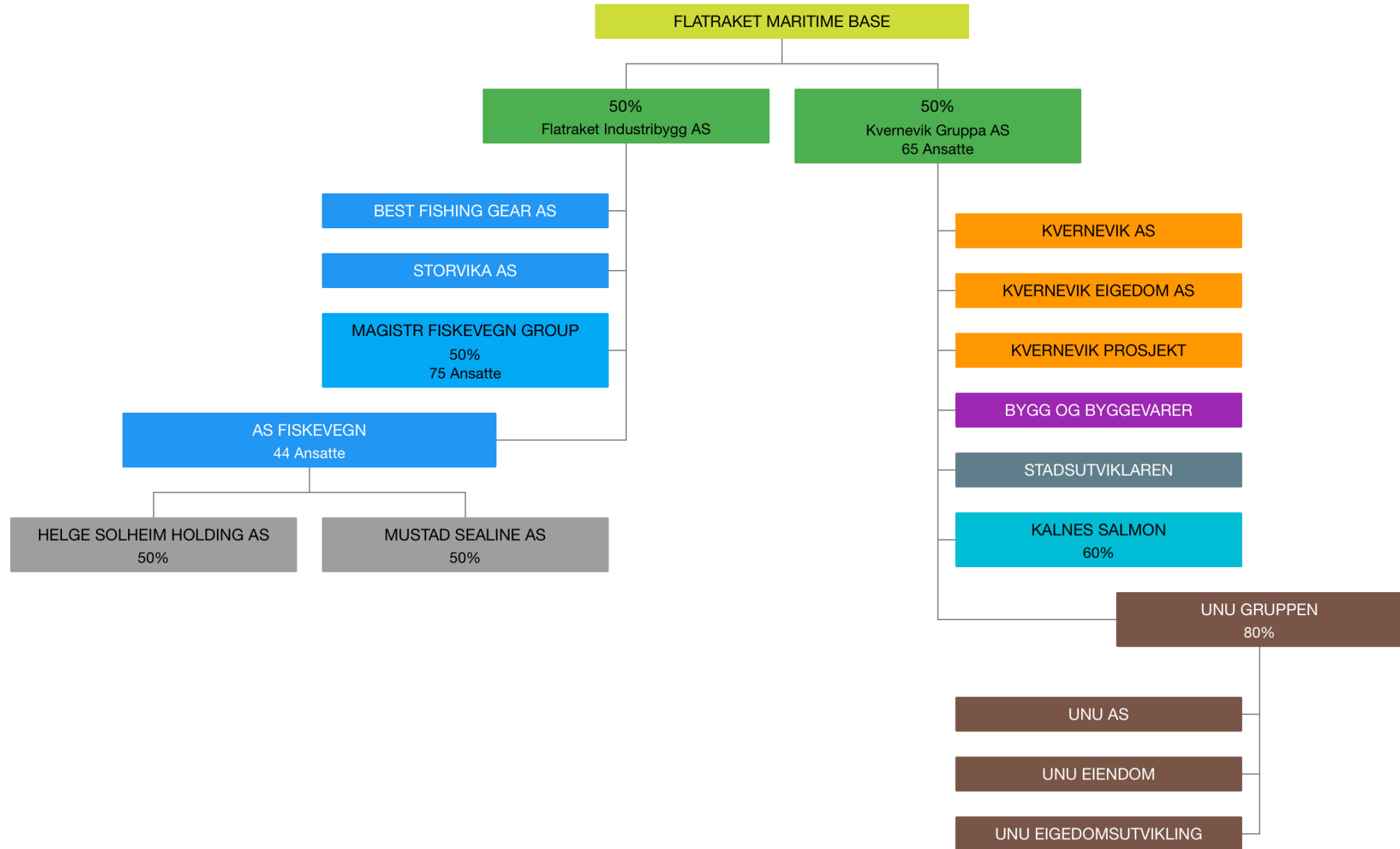

Flatraket Maritime Base

Vi vil benytte oss av masse fra Stad Skipstunnel for å bygge og utvikle en base på Flatraket

- Vi vil legge til rette for utvikling av våre egne selskap
- Vi vil invitere med andre Havnære virksomheter med fokus på det grønne skiftet
- Arealet vil gi rom for nyetableringer
- Gjennom samhandling ønsker vi å oppnå synergier for egne og andre selskaper
- Hopen er avgjørende for hele prosjektet, utforming og plasseringer er naturgitt
- I tilknytning til utfylt areal, er det planlagt område for lukka akvakultur i sjø.
- Daglig leder: Helge Solheim
- Startkapital 1000 000,-
- Vi ønsker en utvikling på Flatraket gjennom å tilrettelegge for nye arbeidsplasser.

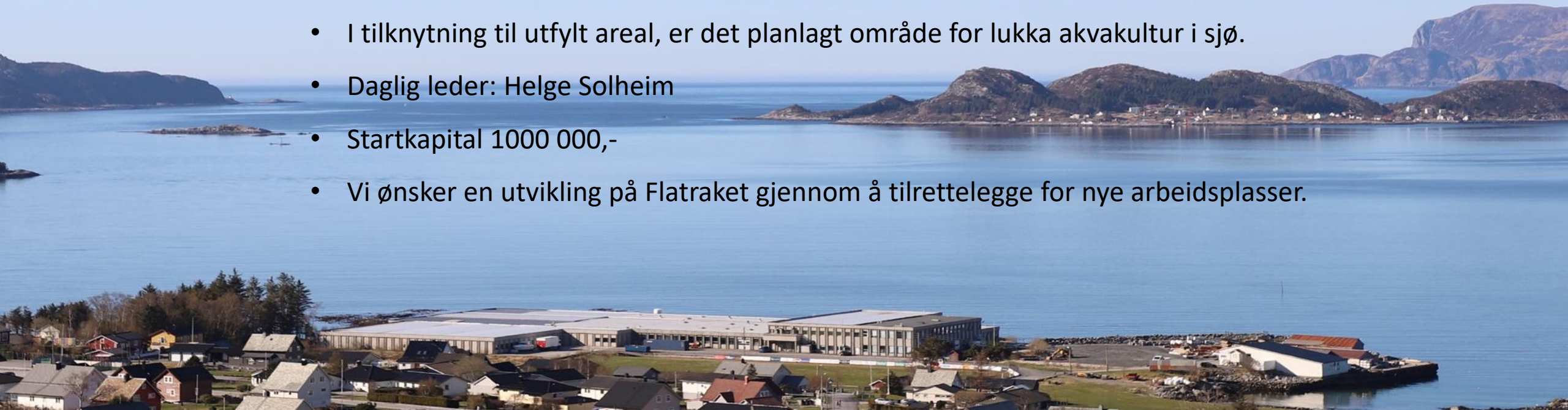

Flatraket Maritime Base

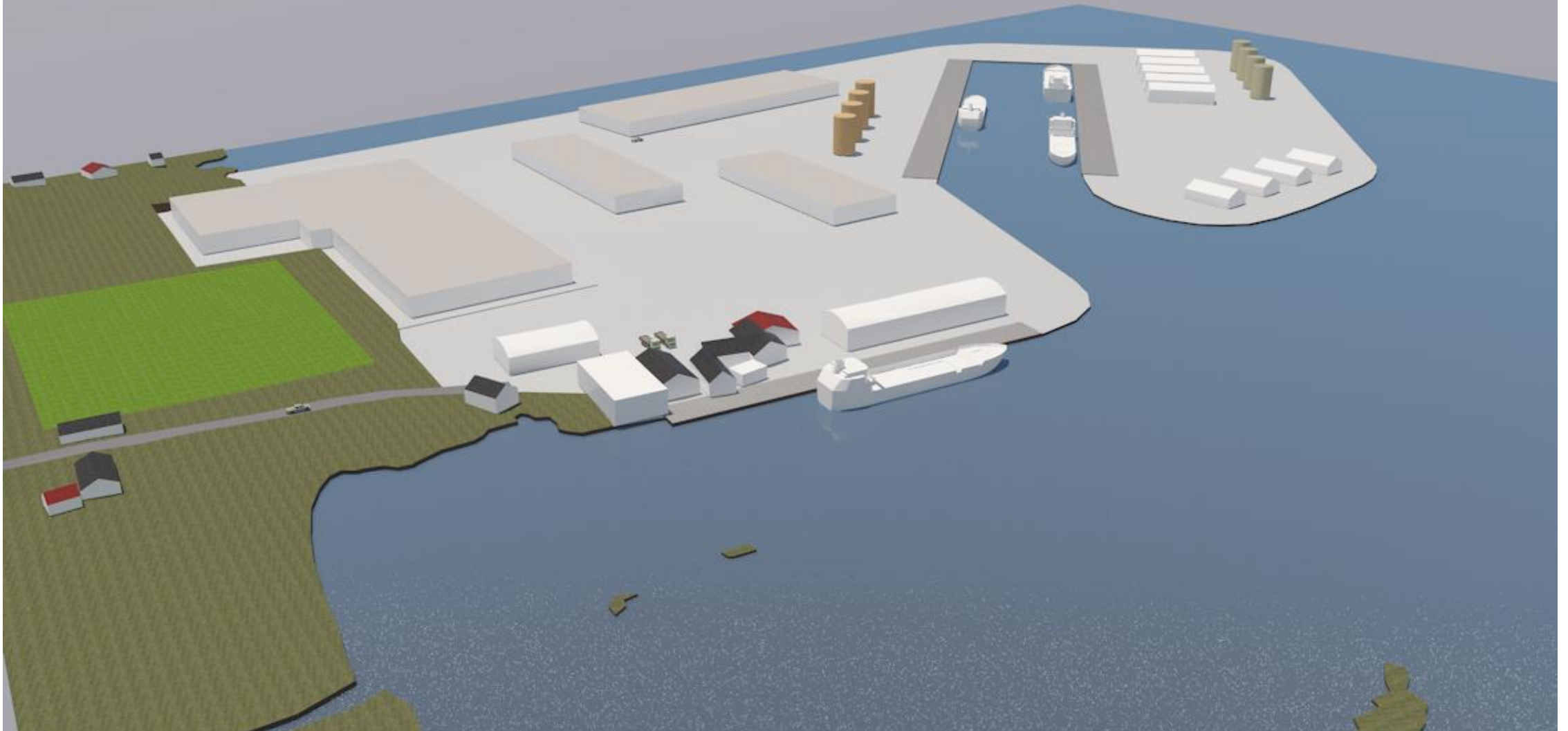

Flatraket Maritime Base



Flatraket Maritime Base

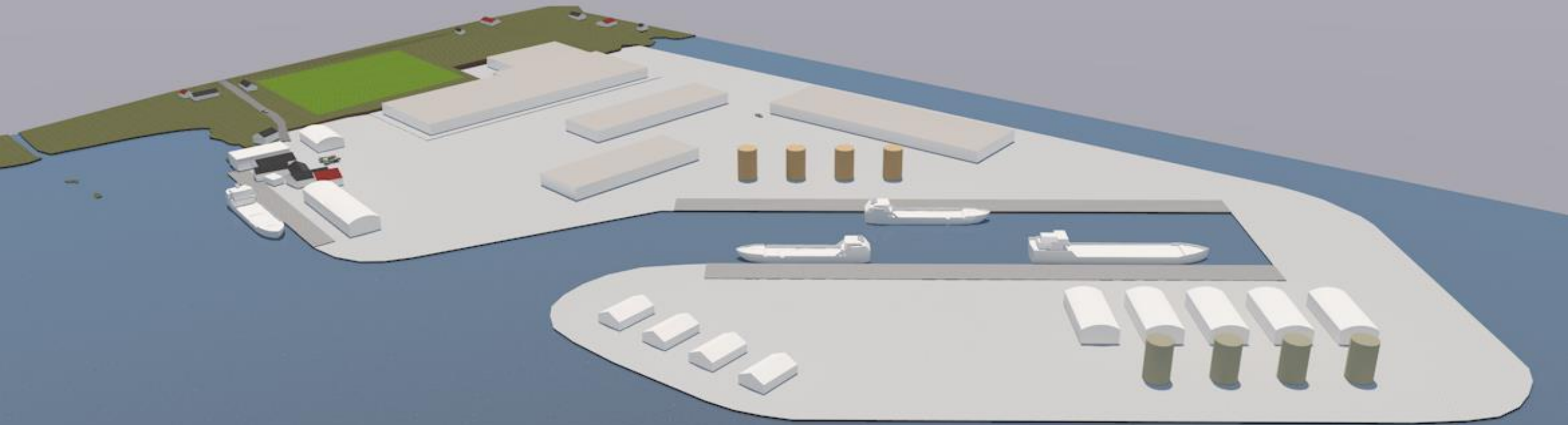

Flatraket Maritime Base

- Vi ønsker å skape fremtidige arbeidsplasser i Stad kommune

Takk for oppmerksomheten!

